



# Electronic Safe Lock Axessor USB

Operating Manual



# Axessor USB

## System overview - Electronic safe lock Axessor USB

---

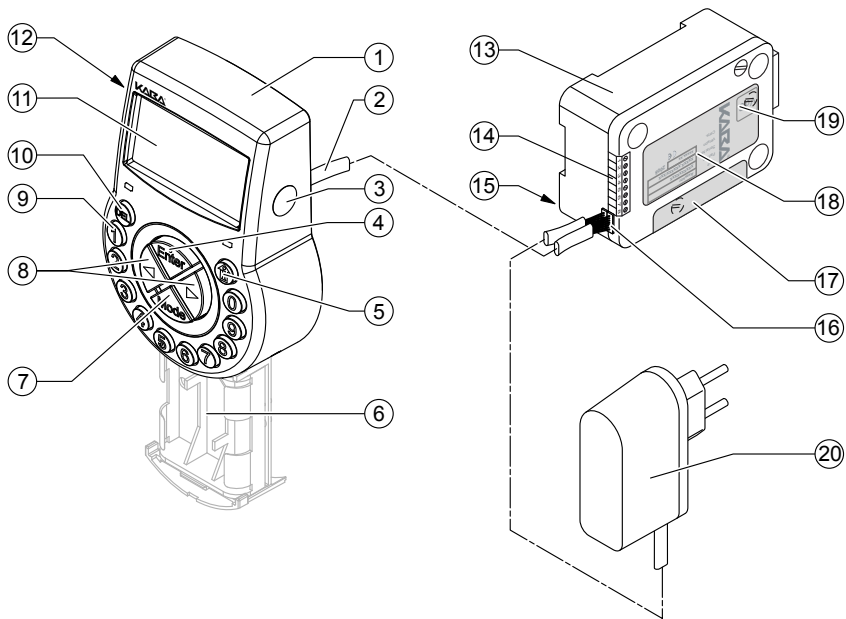

## Input Unit

- 1 Housing
- 2 Connection cable to lock unit
- 3 Interface (USB) for PC connection
- 4 <ENTER> key (enter, confirm)
- 5 <INFO/ESC> key (activate info display or escape/go back to upper level)
- 6 Battery compartment
- 7 <MODE> key (activate Programming Mode)
- 8 <LEFT> and <RIGHT> key (directional keys to navigate)
- 9 <0>...<9> (numeric keys 0...9)
- 10 <DEL> key (delete, close lock)
- 11 LCD (liquid crystal display)
- 12 Buzzer

## Lock

- 13 Lock housing
- 14 Terminal blocks (Inputs/Outputs)
- 15 Pin for cable tie holder
- 16 Connecting socket X1 (cable from input unit) and X2 (external power supply)
- 17 Warranty seal
- 18 Type label
- 19 VdS-label (protects spring bolt setting screw)
- 20 External power supply (option)

## TABLE OF CONTENT

---

<b>1</b>	<b>Introduction</b>	<b>9</b>
1.1	To the very beginning	9
1.2	Notes regarding the Operating Manual	9
1.2.1	Validity	9
1.2.2	Target group	9
1.2.3	Limitation	9
1.2.4	Supplementary documentation	9
1.2.5	Symbols used in this operating manual	10
1.2.6	Text marking	10
<b>2</b>	<b>Safety and Environment</b>	<b>11</b>
2.1	General	11
2.2	Qualification of personnel	11
2.3	Prohibited modifications to the unit	11
2.4	Environment	11
<b>3</b>	<b>Product overview</b>	<b>12</b>
3.1	Product description	12
3.2	Field of application	13
3.3	Intended use	13
<b>4</b>	<b>Installation</b>	<b>14</b>
4.1	Important information prior to the installation	14
4.2	Upacking and checking the delivery	14
4.3	Installing the Input Unit	15
4.4	Installing the lock	20
4.5	Perform wiring check after lock installation	22
4.6	External connections at the lock	23

<b>5</b>	<b>Operating</b>	<b>25</b>
5.1	Operating and display elements of the Input Unit	25
5.2	Operating modes	26
5.2.1	Normal operating mode	26
5.2.2	Programming mode	26
5.2.3	Information menu	26
5.3	Buzzer signals	27
5.4	Status messages	27
5.4.1	Locked	27
5.4.2	Open	27
5.4.3	Immediate time lock	27
5.4.4	Time lock (Weekly)	28
5.4.5	Time lock (Holiday)	28
5.4.6	Time Delay	28
5.4.7	Confirmation after elapse of Time Delay	28
5.4.8	Enter second code (Dual Mode activated)	29
5.4.9	Penalty after wrong trials	29
5.4.10	Remote Disabling	29
5.4.11	Identification with denied code	29
5.4.12	The battery compartment has been opened	30
5.4.13	Connected with Programming Software	30
5.4.14	External power supply available	30
5.5	Access Codes	31
5.5.1	Code hierarchy and code formats	31
5.5.2	Code types	31
5.5.2.1	Master Code	32
5.5.2.2	Manager Codes	33
5.5.2.3	User Codes	33
5.5.2.4	Courier Code	33
5.5.3	Shelve Function	34
5.5.4	Duress Code	34
5.6	Code entry	35
5.7	Opening procedure	36
5.8	Closing procedure	38

<b>6</b>	<b>Programming Mode</b>	<b>39</b>
6.1	Operating the programming mode	39
6.1.1	Activating the programming mode	39
6.1.2	Navigating in the Programming Mode	40
6.1.3	Modify and save settings in the Programming Mode	40
6.1.4	Exiting the Programming Mode	41
6.2	Menu overview	42
6.3	Access rights	43
6.4	Programming	44
6.4.1	Menu TIME	44
6.4.1.1	Setting the time - submenu TIME	44
6.4.1.2	Setting the time - submenu DATE	45
6.4.1.3	Setting the time format - submenu AM/PM	46
6.4.2	Menu PROG	47
6.4.2.1	Configuring Weekly Locking Periods - Submenu WEEKLY	47
6.4.2.1.1	Adding a Weekly Locking Period	47
6.4.2.1.2	Modifying an existing Weekly Locking Period	48
6.4.2.1.3	Deleting an existing Weekly Locking Period	49
6.4.2.2	Activating an Immediate Time Lock - Submenu IMM-TL	50
6.4.2.3	Configuring Holiday Locking Periods - Submenu HOLIDAY	51
6.4.2.3.1	Adding a Holiday Locking Period	51
6.4.2.3.2	Modifying an existing Holiday Locking Period	52
6.4.2.3.3	Deleting an existing Holiday Locking Period	53
6.4.3	Menu DELAY	54
6.4.3.1	Setting/Deactivating Time Delays - Submenus DELAY 1...2	54
6.4.3.2	Configuring the Confirmation Window - Submenu CNF WIN	56
6.4.4	Menu CODE	57
6.4.4.1	Changing the Master Code - Submenu MASTER	57
6.4.4.2	Setting Manager Codes - Submenu MANAGER	58
6.4.4.3	Setting User Codes - Submenu USER	59
6.4.4.4	Setting the Courier Code - Submenu COURIER	60
6.4.4.5	Reset the whole Axessor USB safe lock system to factory defaults - Submenu SHELVE	61
6.4.4.6	Modifying a code	62
6.4.4.7	Deleting a code	63
6.4.5	Menu MISC	64
6.4.5.1	Activating/Deactivating Code Denial - Submenu CDE DEN	64
6.4.5.2	Activating/Deactivating Remote Disabling - Submenu RMT-DIS	65
6.4.5.3	Activating/Deactivating Duress Code function - Submenu DURESS	66
6.4.5.4	Activating/Deactivating Dual Mode - Submenu DUAL	67
6.4.5.5	Setting the display language - Submenu LANG	68

<b>7</b>	<b>Servicing</b>	<b>69</b>
7.1	Cleaning	69
7.2	Replacing the batteries	69
7.3	Customer Service	70
7.4	Spare parts and accessories	71
<b>8</b>	<b>Error messages</b>	<b>72</b>
<b>9</b>	<b>Technical data</b>	<b>75</b>
9.1	Functions	75
9.2	Electronics	77
9.3	Mechanics	78
9.4	Approvals and Certificates	79
9.5	Factory settings	80



## 1 Introduction

---

### 1.1 To the very beginning

We thank you for having opted for the **electronic safe lock Axessor USB**.

The electronic safe lock Axessor USB incorporates the latest technical advances and meets all recognized safety standards. Nevertheless, improper use of the electronic safe lock Axessor USB may result in impairment of material assets.

To ensure a safe, proper, and economical operation of the electronic safe lock Axessor USB, please observe and comply with all information and safety instructions contained in the present Operating Manual as well as the instructions given in the manuals for the components used in conjunction with the safe lock.

If you have questions, which are not or insufficiently answered in this Operating Manual, please contact your supplier. They will be glad to assist you.

---

### 1.2 Notes regarding the Operating Manual

#### 1.2.1 Validity

This Operating Manual describes the **electronic safe lock Axessor USB**.

#### 1.2.2 Target group

This Operating Manual addresses itself to well trained personnel which is in charge with the installation, the commissioning, the operation, the servicing and the trouble shooting of the electronic safe lock Axessor USB.

#### 1.2.3 Limitation

This Operating Manual is restricted to the installation, commissioning, operation, servicing and trouble shooting of the electronic safe lock Axessor USB.

The optional AS 284 Programming Software is only described insofar as this is necessary for proper operation of the safe lock. Further information on the AS 284 Programming Software can be obtained in the help function of the software.

#### 1.2.4 Supplementary documentation

This operating manual is supplemented with the Axessor USB Quick Reference Guide.

### 1.2.5 Symbols used in this operating manual

The following symbols are used in this operating manual to direct your attention on particular situation, e.g. to indicate a hazardous situation, requirements which must be met, etc.:



**Warning!**

Indicates a hazard which can cause damage to the unit or have a serious effect on the function or use of the unit if unobserved.



**Important!**

Indicates important information which must be observed during the described procedure.



**Note!**

Indicates notes, information or pointers, which facilitate work or provide additional background information or point out specific details.

**Requirement!**



Indicates requirements that must be met for the execution, activation, modification or deletion of the described function. These requirements must be met before proceeding.

**AS 284 Programming Software**



Refers to the AS 284 Programming Software (optionally available), which allows additional settings and functions.

### 1.2.6 Text marking

- The character „→“ stands for „see“, „refer to“ or „also consult“  
Sample: for a description of Access Code Hierarchy → *Code hierarchy and code formats on page 31*).
- Text appearing on the display is marked in capitals and set into quotation marks (sample: „LOCKED“).
- Keys to be used are marked in bold capitals and set into angle brackets:
 

<b>&lt;DEL&gt;</b>	= Delete key
<b>&lt;NUMERIC&gt;</b>	= Numeric keys 0...9
<b>&lt;INFO/ESC&gt;</b>	= Information/Escape key
<b>&lt;ENTER&gt;</b>	= Enter key
<b>&lt;MODE&gt;</b>	= Mode key
<b>&lt;LEFT&gt;</b>	= Left arrow key
<b>&lt;RIGHT&gt;</b>	= Right arrow key

## 2 Safety and Environment

---

### 2.1 General

Every person working with the Axessor USB must have read and understood the operating manual before carrying out any work.

Knowing and understanding the contents of the operating manual is a basic requirement for protecting the personnel against any kind of danger, to prevent faulty operation, and to operate the unit safely and correctly.

### 2.2 Qualification of personnel

All actions described in the present operating manual (installation, commissioning, operation, etc.) must be carried out only by well trained and sufficiently qualified personnel.

For safety and warranty reasons any action beyond the scope of this manual must be carried out only by qualified personnel authorised by the manufacturer.

It is assumed that all persons working with the Axessor USB are familiar and comply with the appropriate regulations on work safety and the prevention of accidents.

### 2.3 Prohibited modifications to the unit

Modifications on the electronic safe lock Axessor USB are explicitly not recommended, it may void warranty and impair the security and safety of the unit.

For the replacement of defective components use exclusively original accessories and spare parts available from your supplier.

### 2.4 Environment

Packing and consumable material (e.g. batteries) must be disposed of and/or recycled according to the local regulations.

At the end of the service life the unit and its components must be returned to the manufacturer or to a collecting point for disposal or recycling according to the local regulations.

In case of doubt please contact your supplier.

## 3 Product overview

### 3.1 Product description

The electronic safe lock Axessor USB is an intelligent motor-bolt lock with integrated terminals used for instance to connect to an alarm centre. It features a wide range of functionalities, such as a code hierarchy with User Group management, Courier Code, Dual Mode, Duress Code, Time Delay, Time Lock functions, Remote Disabling and Code Denial. The operation and the programming is done via the Input Unit.

The electronic safe lock Axessor USB may also be configured with the **AS 284 Programming Software (optionally available)**. This gives access to an even enhanced functionality and allows customer-tailored solutions to almost every extent.

#### Unit configuration standard version

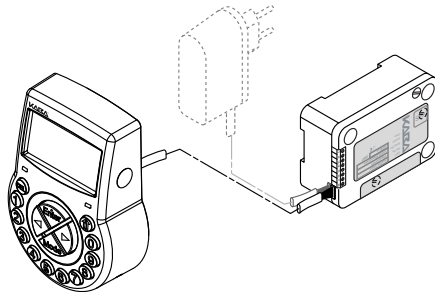

In its standard version the electronic safe lock Axessor USB is battery powered and consist of: the **input unit**, the **lock** and the **connection cable**. The lock includes 2 inputs and 2 outputs (assignment → *External connections at the lock on page 23*). Optionally, an external power supply (6VDC/500mA) can be connected to one of the lock sockets „X1“ or „X2“.

Only use the original Axessor USB power supply. Even if the external power supply is connected, the batteries must remain in the battery compartment at all times. They are mainly but not exclusively used in case of a power failure. Only use **non rechargeable** AA Alkaline or AA Lithium batteries.

## Axessor USB

---

### 3.2 Field of application

The electronic safe lock Axessor USB provides a wide range of functions for applications in the high security sector. They permit programming of various codes and code combinations, time related functions as well as storage and recall of a detailed event log (Audit Trail).

The programming can be done via the input unit or by connecting a computer running the AS 284 Programming Software to the input unit via USB cable.

This electronic safe lock is especially suitable for applications where high security, multiple users, traceability and flexibility are required.

---

### 3.3 Intended use

The electronic safe lock Axessor USB serves to block and release the mechanical blocking point of a safe, vault, data cabinet, ATM etc. which is usually activated manually by a boltwork. The electronic safe lock Axessor USB can be employed instead of a mechanical combination or key lock. Applicable regulations and standards have to be observed.

Enabling (lock opening) is only performed upon entry of one or several codes on the Input Unit. The opening procedure can also be made dependent on time functions and/or external signals.

The electronic safe lock Axessor USB may only be employed and operated in accordance with its intended use – blocking and releasing the mechanical blocking points of above mentioned equipment. Any other type of application is explicitly not recommended.

The electronic safe lock Axessor USB is designed for indoor applications (environmentally protected areas) – they are not suitable for direct exposure to environmental impact.

Operation of the equipment in the intended manner requires that all the information in this operating manual is observed.

## 4 Installation

### 4.1 Important information prior to the installation

**Warning!**

Please observe the following:

- Compliance to described sequence is a necessity. Improper assembly or different sequence may cause damage to the unit!
- To avoid any damage make sure to keep cables away from moving parts! Do not lead cables over sharp edges!
- Do not close the safe door until all installation steps have been completed successfully!

**Important!**

Please observe the following:

- Removal of or damage to the warranty seal (→ System overview - Electronic safe lock Axessor USB on page 3, item 17) voids warranty!
- The mounting screws must be secured against loosening, e.g. by using screw cement, such as LOCTITE 243 (medium, blue).
- Removal of or damage to the VdS label (→ System overview - Electronic safe lock Axessor USB on page 3, item 19) voids VdS approval!
- The lock must not be mounted directly behind leadthroughs! Clog or secure leadthroughs correspondingly. A suitable cover plate to protect the lock is available from your supplier (52x DPUL drilling protection plate).

### 4.2 Unpacking and checking the delivery

Unpack the delivery and check the content of completeness.

The **Axessor USB delivery** includes:

- Input Unit
- Lock
- Connection cable
- Plastic bag containing installation material
- 3 batteries AA-size
- Instruction leaflet with further information and reference to homepage

The **optional computer software packages** include:

- **AS284-USBW**: CD, USB cable, 1 x Operator dongle

## 4.3 Installing the Input Unit

### Mounting the base plate

1. Mark either the fixation bores **3 and 5** or **2 and 4** plus bore **1** (**recommended**). Also mark one of the two bores **6** (cable leadthrough) Do so according to the illustration below or by using the template (→ *Template Input Unit on page 83*).

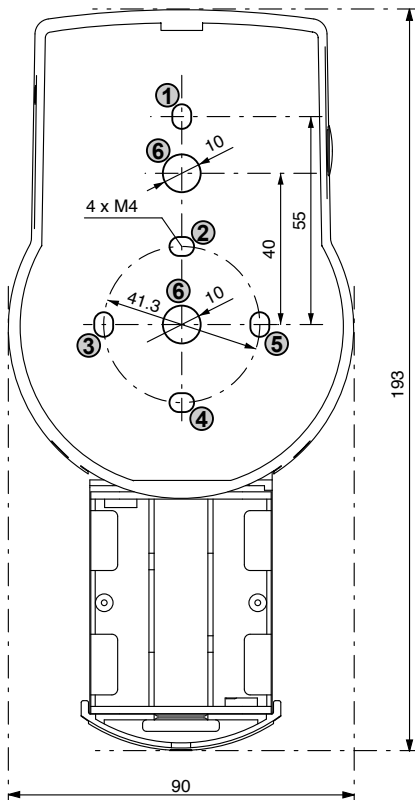

2. Drill the 3 fixation bores  $\text{Ø}3.2 \times 14$  mm and the cable leadthrough bore  $\text{Ø}10$  mm. Remove burrs. Tap M4 threads into the 3 fixation bores.

3. Remove the 3 screws on the bottom of the cover (1 at the battery compartment, 2 at the housing). Lift-off the cover from the base plate, then carefully remove the battery compartment.



4. Fix the base plate with the enclosed special M4x12 flat-head screws to the door. The Input unit must be fixed to the door with at least two oppositely positioned screws. The third screw (Pos. 1) is recommended.





## Axessor USB

### Connecting the cables

5. Carefully lead the enclosed connection cable through the  $\varnothing 10\text{mm}$  bore in the door and carefully draw it towards the lock chamber.



6. Mount battery compartment in place. Then, carefully lead the battery cable through strain relief guides of the battery compartment and the base plate. **Make sure not to squeeze the cable!**

Finally check for free movability of the battery compartment.

**Make sure the spiral cable lays flat when moving the battery compartment (i.e. the cable does not move in other directions when extended and compressed).**

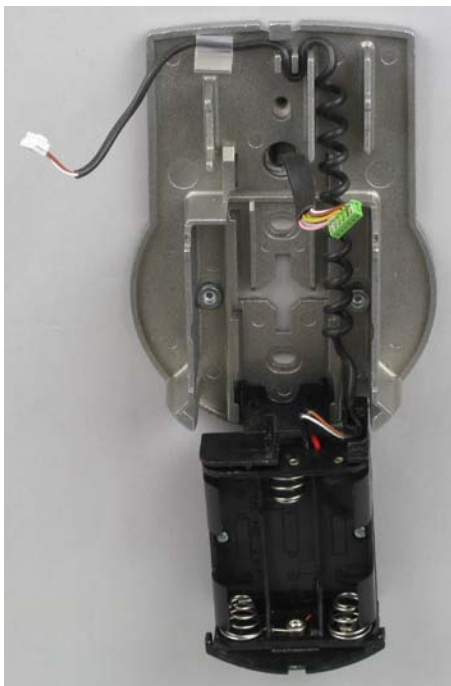

7. Position the cover on top of the base plate in an angle  $>90^\circ$ .



8. Plug the battery cable into the 2 pole connection terminal and the connection cable into the 6 pole connection terminal.  
**Check correct position of the plugs before connecting them. Do not use excessive force to plug-in, but make sure that proper connection is given.**

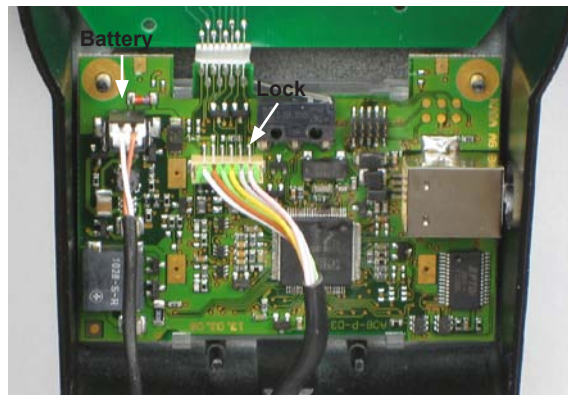

## Axessor USB

### Mounting the cover

9. Engage the cover at notch on top of base plate.

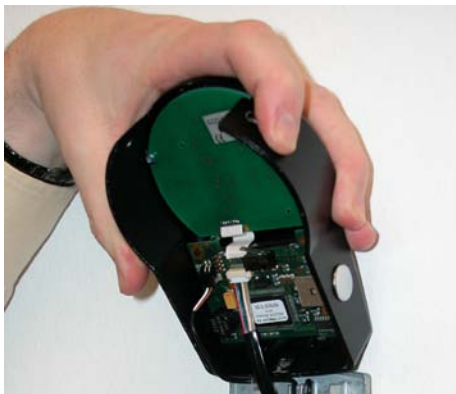

10. Slowly flip down the cover onto the base plate while carefully pulling the connection cable towards the lock chamber; leave some spare loop.  
**Make sure that cables are not squeezed.** Check battery compartment for free movability: carefully push the battery compartment into place, then slide it out again.



11. Fix the cover on the base plate using two M3x6 countersink screws.



12. Check battery compartment for proper movability: carefully push the battery compartment into place, then slide it out again  
**Do not insert the batteries and do not fix the battery compartment screw yet.**

## 4.4 Installing the lock

### Mounting the lock

1. Mark the 3 fixation bores (A) according to the illustration below or by using the template (→ *Template Lock on page 84*).

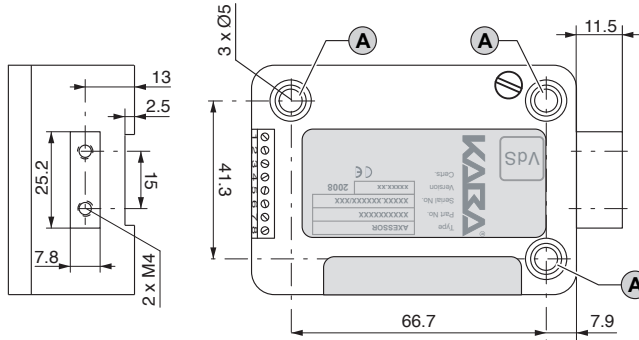

2. Drill the bores  $\varnothing 5\text{mm}$ . Remove the burrs and tap M6 threads into the bores.
3. Mount the lock with the 3 enclosed M6x10 screws (equivalent Inch screws may be used instead).

**Make sure that the screw heads rest on the base of the shouldered bore! Make sure to keep the space underneath the lock free for a re-locker system or the connection cable!**

4. If the lock is to be operated in spring bolt function, remove the retainer screw (B) underneath the VdS label.

**Be aware, that this operating mode voids VdS approval!**



## Axessor USB

- If needed, use the two M4 threads at the front end of the lock bolt to attach an extension.

**Observe the maximum moving force of 5N in both directions.**

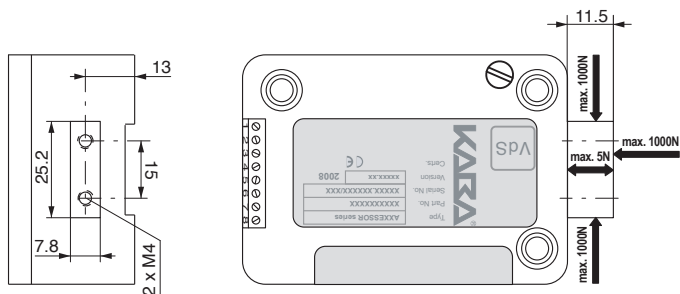

### Connecting the cable

- Verify correct position of the connector, then carefully plug connection cable into one of the lock sockets „X1“ or „X2“.

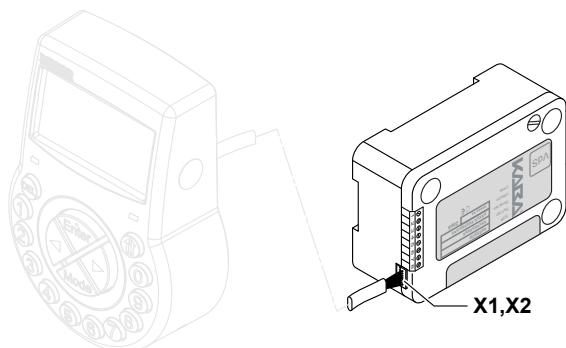

- Secure the cable with the cable tie and carefully fix any excess cable.



## 4.5 Perform wiring check after lock installation



### Requirement

To perform wiring check the door must be open.

- Carefully slide out the battery compartment until it comes to a stop.
- Insert the 3 enclosed batteries (3x AA mignon, Alkaline type) according to the markings in receptacles – **observe polarity!**

As soon as the batteries are inserted a test routine is initiated. The following displays appear successively (version display may vary) and the „BEEP signal“ sounds:



- Close battery compartment. Wait until the error message „BAT-CMP OPEN“ reappears again.



- Confirm the error message by entering the current Master Code (default: 00123456) with the <NUMERIC> keys, then press the <ENTER> key. The lock opens and closes again after approx. 6 seconds.

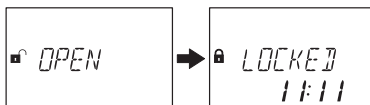

- Fix battery compartment with hexagon countersink screw.



### Important!

If during wiring test the error message „LINE OFF“ continuously appears, the connection cable is either connected incorrectly or it was damaged during installation. Do not continue installation and proceed as follows:

- Check connection cable for correct connection or damage. Disconnect connection cable and replace if necessary.
- Reconnect connection cable as described in sections → Installing the Input Unit on page 15 and Installing the lock on page 20.
- Check whether new batteries were inserted. If not, insert new batteries.

If another error message appeared please refer to section → Error messages on page 72.

# Axessor USB

## 4.6 External connections at the lock

If desired, connect additional external signals at the lock terminal block. Refer to the table and the wiring examples below.

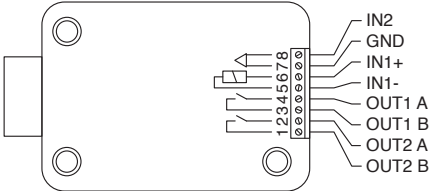
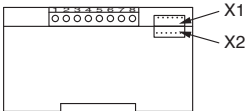
Terminal	Description	Capacity / Remarks
 <p><b>Note: Function and polarity of the Inputs and Outputs can be changed with optional AS 284 Programming Software.</b></p>		
1 / 2	<b>Output 2</b> standard: bolt or motor open	30 VDC/2A, 50 VAC/0.5A with resistive load.
3 / 4	<b>Output 1</b> standard: Duress alarm	Relay with potential-free working contacts (NO - normally open).
5(-) / 6(+)	<b>Input 1</b> standard: not assigned optional: remote disabling, or controlled disabling	12 VDC (min. 20mA)
7 / 8	<b>Input 2</b> standard: not assigned optional: Programmable with AS 284 Programming Software	<b>Do not apply any voltage – potential free contact only!</b> Recommendation: Suitable micro switch with gold-plated contacts for 12 VDC/50mA (e.g. „DB series“ by Cherry).
Socket	Description	Capacity / Remarks
		
X1, X2	Connection to input unit or Connection of power supply	Enclosed connection cable must be used.  Use only the original Axessor power supply that is available as optional accessory

Example of wiring „Door Contact“

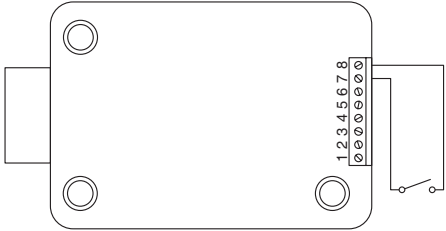

Example of wiring several locks in a way that only one lock may be opened at the same time

The following settings must be made with the AS 284 Programming Software in addition:

Output 2= bolt or motor open

Input 1= Controlled disabling

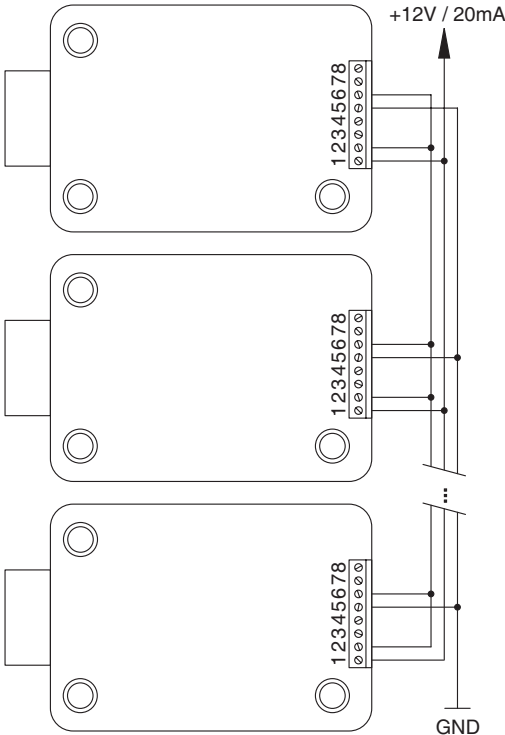



## 5 Operating

### 5.1 Operating and display elements of the Input Unit

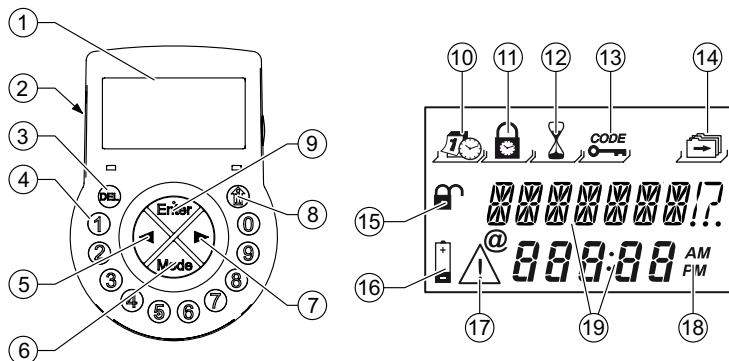

- 1 LC-Display
- 2 Buzzer
- 3 <DEL> (delete, close lock)
- 4 <NUMERIC> keys (numeric keys 0...9)
- 5 <LEFT> key (directional key to navigate)
- 6 <MODE> key (activate Programming Mode)
- 7 <RIGHT> key (directional key to navigate)
- 8 <INFO/ESC> key (activate info display or escape/go back to upper level)
- 9 <ENTER> key (enter, confirm)
- 10 Menu TIME (to set time/date)
- 11 Menu PROG (to program Locking Periods)
- 12 Menu DELAY (to program Time Delays)
- 13 Menu CODE (to modify codes)
- 14 Menu MISC (to access additional settings)
- 15 Symbol „Lock open“ (unlocked) or „Lock closed“ (locked)
- 16 Symbol „Replace batteries“
- 17 Symbol „Warning“
- 18 Time format (12/24 Hrs.)
- 19 Text lines

---

## 5.2 Operating modes

### 5.2.1 Normal operating mode

Normal operating mode for opening/closing operation. All programmed functions are carried out, alarms will be supported and forwarded, diagnose is carried out and possible errors are displayed with a message.

### 5.2.2 Programming mode

The Programming Mode is used to alter factory set parameters and to change settings, codes etc. Depending on the programming level, different codes are required.

### 5.2.3 Information menu

The information menu is accessible by pressing the **<INFO/ESC>** key while the display shows "OPEN" or "LOCKED". By repetitive pressing the **<INFO/ESC>** key or the arrow keys the individual information of the information menu can be queried in sequence. The sequence of the information depends on whether a time lock is active or not:

- Sequence, if no time lock is active:
  - Display language
  - Battery charge condition (in % of the nominal capacity)
  - Opening counter
  - Serial number
  - Wait 000:00
- Sequence, if time lock is active:
  - Wait with hhh:mm until locking period has elapsed
  - Display language
  - Battery charge condition (in % of the nominal capacity)
  - Opening counter
  - Serial number



---

#### **Notes!**

- *The display language can be changed within the information menu at any time by pressing the <ENTER> key (even if the lock is closed).*
  - *The information menu is quitted automatically after 10 seconds without action or can be quitted manually by pressing the <DEL> key.*
-

## 5.3 Buzzer signals

Buzzer signal	Display	Cause
1 short beep		Key stroke
1 short, low-frequency beep	REFUSED	Action refused
1 short beep every 60 seconds	WAIT	Time Delay or Duress Time Delay active
3 short beeps every 60 seconds	CONF	Confirmation Window active (waiting for confirmation code after elapse of Time Delay)
10 short beeps every 10 seconds	BAT-CMP OPEN	Battery compartment has been opened
10 short beeps every 30 seconds	OPEN	Lock open



### AS 284 Programming Software

- Buzzer signal during „OPEN“ (lock open), during „WAIT“ (Time delay) and during „CONF“ (Confirmation window) can be deactivated.
- Buzzer volume may be set to „high“, „low“ or „off“.

## 5.4 Status messages

During normal operation the following status messages can occur:

### 5.4.1 Locked



The lock is mechanically closed – the current time is displayed. It may be opened by entering a valid code.

### 5.4.2 Open



The lock is mechanically open. The boltwork or the safe door can be opened during a set period of time (factory default: 6 seconds). If the boltwork is not opened, the lock automatically closes after the set bolt open time has elapsed.

### 5.4.3 Immediate time lock

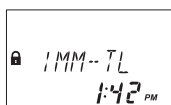

The lock is blocked by the Immediate time lock function and cannot be opened – the current time is displayed. It may only be opened by entering a valid code once the set Locking Period has elapsed.

#### 5.4.4 Time lock (Weekly)

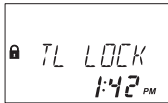

The lock is in a Weekly Locking Period and cannot be opened – the current time is displayed. It may only be opened by entering a valid code once the set Locking Period has elapsed.

#### 5.4.5 Time lock (Holiday)

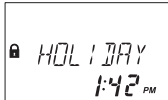

The lock is in a Holiday Locking Period and cannot be opened – the current time is displayed. It may only be opened by entering a valid code once the set Locking Period has elapsed.

#### 5.4.6 Time Delay

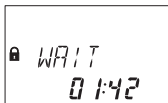

After entering a valid code to open the lock the set Time Delay starts counting – the remaining time is displayed. A „BEEP signal“ is emitted every 60 seconds. Once the counter has elapsed, the end of the Time Delay is indicated with another „BEEP signal“.



##### Notes!

- The duration of a Time Delay may vary between the code groups.
- If the <DEL> key is pressed, the Time Delay is reset and the lock automatically returns to „LOCKED“ status.
- The Courier Code overrides a Time Delay if not defined differently.
- An input may be defined to

#### 5.4.7 Confirmation after elapse of Time Delay

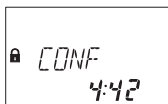

Once the Time Delay has elapsed, a code must be entered again as confirmation, within a set period of time. The remaining time allowance to enter the code is displayed. An „BEEP signal“ is emitted every 60 seconds. If the code is not confirmed, the lock automatically returns to locked status once the counter reached 00:00.



##### Notes!

- If the <DEL> key is pressed, the lock automatically returns to „LOCKED“ status.
- If Dual Mode is activated proceed as follows in the confirmation window: Repeat two codes for confirmation, whereby the sequence is irrelevant.

## 5.4.8 Enter second code (Dual Mode activated)

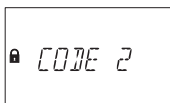

If Dual Mode is activated, 2 codes must be entered to open the lock. This message prompts you to enter the second code.



### Notes!

*Master Code and Courier Code override the Dual Mode – the lock can be opened without any additional code if not defined differently.*

## 5.4.9 Penalty after wrong trials

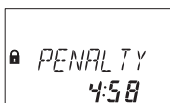

A time penalty of 5 minutes is initiated after the fourth consecutive incorrect code is entered upon opening or accessing programming mode. During this period no code entries are accepted, neither bypassing nor cancellation is possible. The remaining penalty time is displayed.

## 5.4.10 Remote Disabling

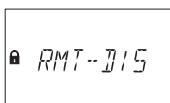

Local opening of the lock can be disabled by a remote input signal (disabling signal). While Remote Disabling is active this message is shown while the lock is closed.

## 5.4.11 Identification with denied code

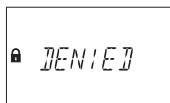

Codes can be denied with a superior code, i.e. declared as invalid until possible further re-permission. Identification with a denied code is answered with this message. The selected function is not executed, the lock condition remains unchanged. This message is also displayed upon attempting to open the lock with a Manager Code or the Master Code if the respective Code type is set to „cannot open“.

#### 5.4.12 The battery compartment has been opened



If the battery compartment, which also serves as a dismantling protection for the Input Unit, has been opened. This message appears when

- lock is open while battery compartment is open, and when
- lock is locked and the battery compartment has been opened and closed again.

The message can only be deleted by entering a valid Master Code or Manager Code.

#### 5.4.13 Connected with Programming Software



While the lock is connected to a computer via **USB** cable and a data exchange with the AS 284 Programming Software (optionally available) is in progress, the opposite display is shown. The Input Unit is not operative, all keys are disabled.

#### 5.4.14 External power supply available



A dot is shown in the display if external power on the lock. This status is updated every full hour.

# Axessor USB

## 5.5 Access Codes

### 5.5.1 Code hierarchy and code formats

For operation and programming a Master Code, Manager Codes, User Codes and a Courier Code are available. Each code consists of an 8 digit number composed of an **ID** (identification) **and** a **PIN** (Personal Identification Number).

- The ID (2 digits) is predefined and identifies the code type.
- The PIN (remaining 6 digits) can be individually chosen.

### 5.5.2 Code types

The factory set Master Code 0 0 1 2 3 4 5 6 is identical on all locks of this type, and therefore not suitable for daily use.

Upon initialization and testing the Master Code must be changed to an individually selected code.

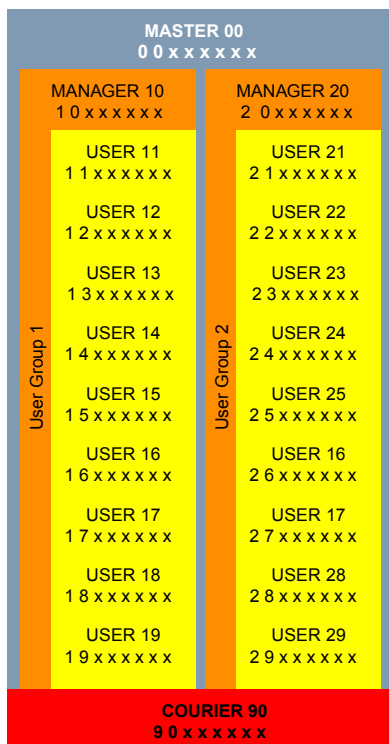

**Important!**

*During commissioning and start-up of the unit all codes must be personalized. Never use any simple combination of numbers (e.g. 11223344, 12345678) or personal data (e.g. birthdays). For safety reasons, codes should be altered at regular intervals!*

**5.5.2.1 Master Code**

The Master Code is the highest code within the code hierarchy. It **cannot** be deleted.

Factory setting:     0 0 1 2 3 4 5 6

Functions:           Opening the lock (even alone in Dual Mode)

                          Alteration of all codes

                          Accessing full range of function

**AS 284 Programming Software**

*The Master Code can be defined as „cannot open the lock“. Thereupon, entering the Master Code for lock opening is confirmed with the message „DENIED“ – the lock does not open.*

**Warning!**

*Lost codes can only be deleted and redefined with a higher-level code. Please take note, that a lost Master Code can neither be located nor restored under any circumstances. There is no so called „Override code“ or „Super code“!*



## Axessor USB

### 5.5.2.2 Manager Codes

2 Manager Codes (Manager Code 1 and Manager Code 2) are available. Each Manager Code can administrate a group of User Codes.

*Factory setting:* no code assigned

*Functions:* Opening the lock

Alteration of own Code

Activation, deletion and alteration of subordinated User Codes

Denial and permission of subordinated User Group

Alteration of subordinated Time Delay and Confirmation Window

Activation of Immediate Time Lock function

Reading audit with AS 286 Audit Viewer

### 5.5.2.3 User Codes

A total of 18 User Codes in 2 groups of up to 9 each can be defined. User Codes can be defined even if no Manager Code is active.

*Factory setting:* no code assigned

*Functions:* Opening the lock

Alteration of respective User Code

### 5.5.2.4 Courier Code

1 Courier Code can be provided to personnel filling/emptying secured containers (CIT - Cash-In-Transit Services) without any programmed Time Delays being of relevance.

*Factory setting:* no code assigned

*Functions:* Opening the lock (even alone in Dual Mode) by bypassing Time Delay

Alteration of Courier Code

### 5.5.3 Shelf Function

All codes, parameters and data (e.g Locking Periods, Time Delays etc.) are reset to factory settings. Audit Trail, opening counter and Time/Date setting remain unchanged. This function is only available if Programming Mode is accessed with Master Code.

### 5.5.4 Duress Code

If the lock is connected to an external alarm system, a silent duress alarm (unnoticeable for the aggressor) can be initiated by the operator.

To trigger a duress alarm, the **value 1 has to be added or deducted to the last digit of the code as standard**. Duress alarms can be initiated with all code types at any time.

Example:	Code		Duress Code
	00123456	---->	00123457 or 00123455
	00000000	---->	00000001 or 00000009
	00999999	---->	00999990 or 00999998

Entering the Duress Code for lock opening starts the set Duress Time Delay.



#### **Requirement!**

*Duress Codes are recognized only if this function is enabled by the Master Code (➔ Activating/Deactivating Duress Code function - Submenu DURESS on page 66).*



*After entering a Duress Code, the duress status is maintained until the Duress Time Delay has elapsed and the lock has been opened, one more non-duress code has been entered!*



#### **AS 284 Programming Software**

- Two Duress Time Delays are available:
  - the first is valid for Master, Manager 1 and Users 11 ... 19
  - the second for Manager 2 and Users 21 ... 29
- The Duress Time Delays can be set independent (longer or shorter) of the normal Time Delays.

### 5.6 Code entry

Codes are entered in 2 groups of 4 digits. To enter a code (to open the lock or to enter the Programming mode) proceed as follows:

1. Press any key to wake up the display (if necessary). The lock status appears (e.g. „LOCKED“).
2. Key-in the Code (e.g. 11123456) using the <NUMERIC> keys (an asterisks appears for every digit entered).

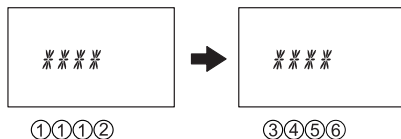

3. Press the <ENTER> key to confirm the Code.



#### **Note!**

*During code entry a possible observer can be diverted. Only the first 7 and the last entered digit will be considered as code.*

- *Enter your code as usual (at least the first 7 digits) and keep on adding any combination as desired.*
- *Enter the last digit of your code and press the <ENTER> key.  
(Example: **00123458921031...256<ENTER>**)*

### 5.7 Opening procedure

The Display switches off automatically after 1 minute without any key being pressed.

- 1. Press any key to wake up the display (if necessary).The lock status appears.



- 2. Key-in the Code (e.g. 11123456) using the <NUMERIC> keys (an asterisk appears for every digit entered). Press the <ENTER> key to confirm the Code.

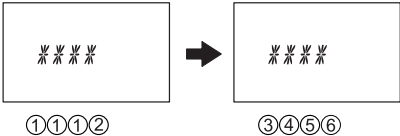

- 3. If unit is set to Dual Mode enter second code as described above. Press the <ENTER> key to confirm the Code.

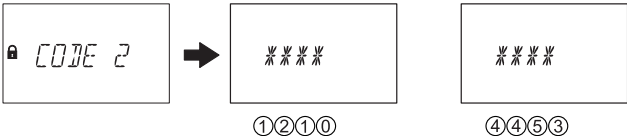

- 4. If a opening time delay is defined the opening delay window appears and the set delay time starts to count - the remaining time is shown. Every 60 seconds a beep sounds while the delay time counts. If the timer has elapsed another beep indicates the end of the opening delay.

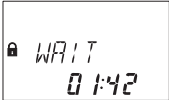

After the opening delay has elapsed the confirmation window appears and the set confirmation time starts to count - the remaining time within the opening must be confirmed is shown.



## Axessor USB

Enter the opening code as described in step 2. Press the **<ENTER>** key to confirm the Code.

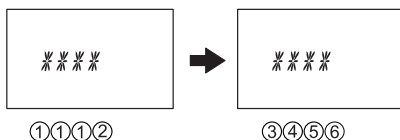

If unit is set to Dual Mode enter second code as described above. Press the **<ENTER>** key to confirm the Code.

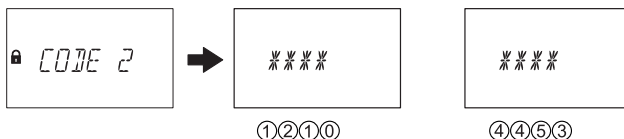

The lock opens.



5. Open the safe.
6. If desired continue in Programming Mode (→ *Programming Mode on page 39*).



### **Note!**

*Opening is not possible during following conditions:*

- *Penalty after wrong trials (→ page 29).*
- *During active Locking Period (Immediate, Weekly, Holiday) (→ page 27 and page 28).*
- *While the battery compartment is open (→ page 30).*
- *During Remote Disabling is in process (→ page 29).*
- *Active connection with the Programming Software (→ page 30).*

---

## 5.8 Closing procedure

The lock normally closes automatically when the boltwork is closed.



---

**Note!**

*Depending on the safe design the closing procedure can be made dependent on additional factors.*

*Contact the supplier of the safe or consult section (→ Installing the lock on page 20).*

---

## 6 Programming Mode

### 6.1 Operating the programming mode

#### 6.1.1 Activating the programming mode

1. Open the lock (→ *Opening procedure on page 36*).



2. Press the <MODE> key.

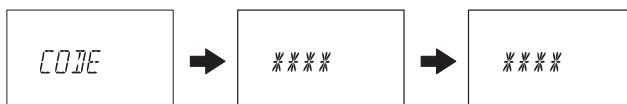

3. Enter the code, e.g. „16023054“ using the <NUMERIC> keys and confirm the code with the <ENTER> key.



You are now in the programming mode. The main menu is displayed. The content of the main menu depends on the code you have entered.



#### **Important!**

*If no key is pressed in programming mode within 1 minute, the unit returns automatically to normal operating mode and the display switches off. Any changes which have not been confirmed with the <ENTER> key and the message „ACCEPTED“ will be lost!*

### 6.1.2 Navigating in the Programming Mode

- Use the <LEFT> and <RIGHT> key to:
  - scroll to a menu item within the main menu or the submenu.
  - select an individual digit or entry field within a settings display.
- Use the <ENTER> key to confirm settings and selections.
- Use the <INFO/ESC> key to quit a setting or submenu without action and jump to the next higher menu level..
- Use the <DEL> key to delete selected data from a submenu or menu item.
- Use the <MODE> key to quit the Programming Mode and return to Normal Operating Mode.

### 6.1.3 Modify and save settings in the Programming Mode

To modify a individual setting proceed as follows:

1. Select the desired setting in the menu (e.g. „TIME“) and press the <ENTER> key.



2. Modify the setting according to the instructions for the corresponding setting (→ *Programming on page 44*).



3. Confirm the setting with the <ENTER> key.



4. In the upcoming save dialogue select „YES“ using the <LEFT> or <RIGHT> key (if necessary), then press the <ENTER> key to save the setting. The Message „ACCEPTED“ appears shortly and the unit returns to the corresponding setting.



**Note!**

- The modification dialogue can be interrupted without saving at any time by pressing the <INFO/ESC> key. Any changes will not be saved.
- The save dialogue can be cancelled by selecting „NO“ with the <LEFT> or <RIGHT> key and pressing the <ENTER> key!



### 6.1.4 Exiting the Programming Mode

Press the <MODE> key or press repeatedly the <INFO/ESC> key (jumps to the next higher menu level) to return to normal operating mode.



---

**Important!**

*Any changes which have not been confirmed with the <ENTER> key and the message „ACCEPTED“ will be lost!*

---

## 6.2 Menu overview

The following menus and submenus (settings) are available in Programming Mode:

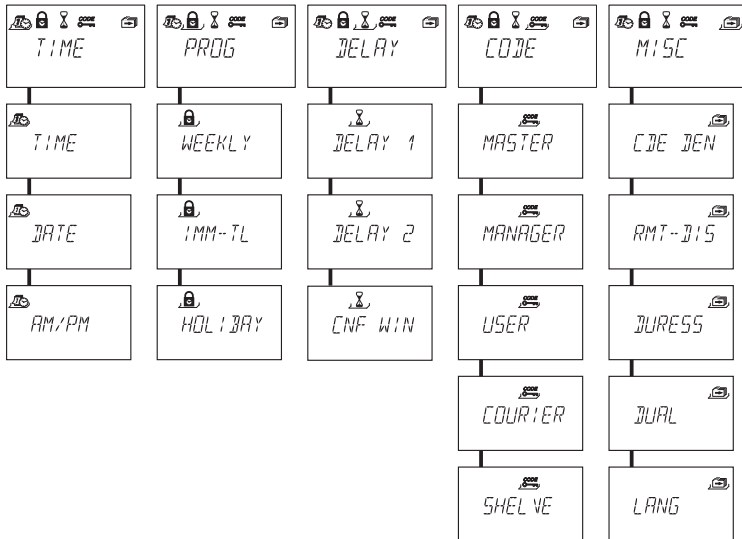

### Menu „TIME“ (setting time, date and time format)

Submenus: „TIME“, „DATE“, „AM/PM“



### Menu „PROG“ (configuring Locking Periods)

Submenus: „WEEKLY“, „IMM-TL“, „HOLIDAY“



### Menu „DELAY“ (configuring Time Delays)

Submenus: „DELAY 1“, „DELAY 2“, „CNF WIN“



### Menu „CODE“ (modifying codes)

Submenus: „MASTER“, „MANAGER“, „USER“, „COURIER“, „SHELVE“



### Menu MISC (accessing additional settings)

Submenus: „CDE DEN“, „RMT-DIS“, „DURESS“, „DUAL“, „LANG“

## 6.3 Access rights

Depending on the access code used upon activating the Programming Mode the following entries and settings can be made.

Function	Authorization				Remarks
	MA	Mx	U	C	
Set <b>Date</b>	✓				
Set <b>Time</b>	✓				
Set <b>Time format</b>	✓				
Set <b>Weekly Locking Period</b>	✓				
Activate <b>Immediate Time Lock function</b>	✓	✓			
Set <b>Holiday Locking Period / repeated Holiday Locking Period</b>	✓				
Set <b>Time Delays</b>	✓				Master: Time Delays 1 ... 2 Manager 1: Time Delay 1 Manager 2: Time Delay 2
Set <b>Confirmation Window</b>	✓				
Change <b>Master Code</b>	✓				Master Code <b>cannot</b> be deleted!
Change <b>Manager Code</b>	✓	✓			
Delete <b>Manager Code</b>	✓				Respective User Codes <b>will not be</b> deleted!
Change <b>Courier Code</b>	✓			✓	
Delete <b>Courier Code</b>	✓				
Delete <b>User Codes</b>	✓	✓			
Change <b>User Code</b>	✓	✓	✓		User can only change <b>own</b> code!
Employ <b>Shelve Function</b>	✓				
Deny/permit <b>subordinated codes</b>	✓	✓			Entire group of User Codes will be denied/permitted!
Activate/deactivate <b>Remote Disabling</b>	✓				
Activate/deactivate <b>Duress Code</b>	✓				
Activate/deactivate <b>Dual Mode</b>	✓				
Change <b>Display Language</b>	✓	✓			

Legend:     **MA** Master Code                             **U** User Codes  
              **Mx** Manager Codes 1, 2                   **C** Courier Code

## 6.4 Programming



### **Requirement!**

To enable the programming the lock must remain open during the entire programming procedure.



### **Important!**

If no key is pressed for 1 minute in the Programming Mode the display will be turned off and the Programming Mode will automatically be exit. Any unsaved entries will be lost!



### 6.4.1 Menu TIME

#### 6.4.1.1 Setting the time - submenu TIME

Authorization: **Master Code**

1. Select the submenu „TIME“.



2. Press the <ENTER> key. The currently set time is displayed.



3. Enter the time using the <NUMERIC> keys. After each number the cursor moves automatically one digit to the right. Use the <LEFT> or <RIGHT> key to select an individual digit to modify..



### **Note!**

If time format „AM/PM“ is activated (→ Setting the time format - submenu AM/PM on page 46) the time must be entered in 12-Hour-Format (e.g. 14:25 as 02:25 PM). The suffix AM or PM can be selected with the <RIGHT> key.

4. Press the <ENTER> key and confirm the setting in the save dialogue.



## 6.4.1.2 Setting the time - submenu DATE

Authorization: **Master Code**

1. Select the submenu „DATE“.



2. Press the **<ENTER>** key. The currently set date is displayed.



3. Move the cursor to its left limit using the **<LEFT>** key. Enter the month (2 digits: January= 01, February= 02, ... December= 12), the day (2 digits) and the year (4 digits) using the **<NUMERIC>** keys. After each entry the cursor moves automatically one digit to the right. Use the **<LEFT>** or **<RIGHT>** key to select an individual digit to modify.
4. Press the **<ENTER>** key to confirm the set date in the save dialogue



---

### **Note!**

*The respective weekdays and leap years are automatically calculated with the internal calendar (calendar range: Jan-1-2002 ... Dec-31-2099).*

---



### 6.4.1.3 Setting the time format - submenu AM/PM

Authorization: **Master Code**

1. Select submenu „AM/PM“.



2. Press the <ENTER> key. The currently set time format is displayed.



3. Select either „ON“ or „OFF“ by toggling with the <LEFT> or <RIGHT> key.



---

**Note!**

With „AM/PM ON“ the time is displayed in 12-Hour-Format (1:00 – 12:59 with suffix AM (ante meridiem = before noon) or PM (post meridiem = after noon).

With „AM/PM OFF“ the time is displayed in 24-Hour-Format (00:00 – 23:59).

---

4. Press the <ENTER> key to confirm the setting in the upcoming save dialogue.



## 6.4.2 Menu PROG

### 6.4.2.1 Configuring Weekly Locking Periods - Submenu WEEKLY

Up to 16 weekly repeated time windows can be defined, during which the lock cannot be opened (e.g. outside business opening hours).

Authorization: **Master Code**

#### 6.4.2.1.1 Adding a Weekly Locking Period

1. Select submenu „WEEKLY“.



2. Press the **<ENTER>** key. If any Weekly Locking Periods are already defined, the settings for the starting point of first Locking Period is displayed.



3. Press the **<LEFT>** or **<RIGHT>** key until „<---+--->“ is displayed.

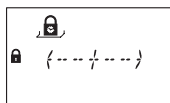

---

#### **Note!**

*If the maximum of 16 Weekly Locking Periods are already defined „<----->“ is displayed. No additional Locking Period can be defined.*

---

4. Press the **<ENTER>** key.
5. Use the **<NUMERIC>** keys to set the day and the time of the **starting point of the Locking Period** (indicated by the „lock closed“ symbol).

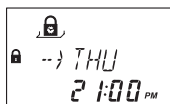



**Note!**

Time and day entry depend on the AM/PM setting (→ Setting the time format - submenu AM/PM on page 46).

If time format is set to 12-hours (AM/PM On) the week days are numbered:

Sunday= 1, Monday= 2, ... Saturday= 7;

If time format is set to 24-hours (AM/PM Off) the week days are numbered:

Monday= 1, Tuesday= 2, ... Sunday= 7.

6. Press the <ENTER> key to confirm the setting in the upcoming save dialogue.
7. Use the <NUMERIC> keys to set the day (→ note below step 5) and the time of the **end point of the Locking Period** (indicated by the „lock open” symbol).



8. Press the <ENTER> key to confirm the setting in the upcoming save dialogue.
9. Repeat steps 2 to 7 to define other Locking Periods or press the <Info/Esc> key to exit the function.



**Note!**

- Weekly Locking Periods can last 1 minute to 6 days, 23 hours and 59 minutes.
- Between two Weekly Locking Periods opening must be possible. Therefore the time gap must be larger than: the defined Time Delay (or Duress Time Delay, if larger) + the Confirmation Window + one additional minute.
- Weekly Locking Periods are saved in chronological order, starting with Monday.

**6.4.2.1.2 Modifying an existing Weekly Locking Period**

Proceed as described for adding a new Weekly Locking Period (→ Adding a Weekly Locking Period on page 47). Instead of „<- - + ->” select the Weekly Locking Period you wish to alter and overwrite it.



## Axessor USB

### 6.4.2.1.3 Deleting an existing Weekly Locking Period

1. Select submenu „WEEKLY“.



2. Press the **<ENTER>** key. The starting point of the first defined Weekly Locking Period is displayed.
3. Use the **<LEFT>** or **<RIGHT>** key to select the starting point of the Weekly Locking Period (indicated by the „lock closed“ symbol) you wish to delete.

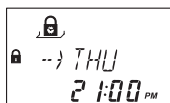

4. Press the **<DEL>** key.
5. In the upcoming delete dialogue select „YES“ using the **<LEFT>** or **<RIGHT>** key, then press the **<ENTER>** key. The corresponding Locking Period will be deleted.

### 6.4.2.2 Activating an Immediate Time Lock - Submenu IMM-TL

This function permits activation of a Locking Period with immediate action. Upon closing the lock **cannot** be opened for the programmed duration.

Example: For shorter business hours due to public holiday, the time until beginning of the regular Locking Period can be bridged.

Authorization: **Master Code or any Manager Code**



#### AS 284 Programming Software

- Only if the Manager Codes are defined as: „can activate Immediate Time Lock“, this setting is available with Manager Codes.
- Only if the User Codes are defined as: „can activate Immediate Time Lock“, this setting is available with User Codes.

1. Select submenu „IMM-TL“.

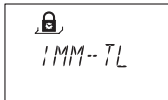

2. Press the <ENTER> key.

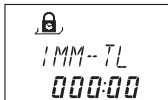

3. Use the <NUMERIC> keys to set the duration in hours the Immediate Time Lock should be active after the lock is closed.
4. Press the <ENTER> key to confirm the settings in the upcoming save dialogue.



#### Notes!

- Maximum duration is 144 hours.
- Overwriting with „000:00“ will deactivate the Immediate Time Lock.
- The Immediate Time Lock is not related to Time/Date. Therefore, by changing Time/Date setting the Immediate Time Lock cannot be bypassed.

## 6.4.2.3 Configuring Holiday Locking Periods - Submenu HOLIDAY

This function permits defining of up to 22 date-related time windows, during which the lock cannot be opened (e.g. during holidays or on public holidays).

Authorization: **Master Code**

### 6.4.2.3.1 Adding a Holiday Locking Period

1. Select submenu „HOLIDAY“.



2. Press the <ENTER> key. If any Holiday Locking Periods are already defined, the settings for the starting point of the first Locking Period is displayed.



3. Press the <LEFT> or <RIGHT> key until „<-- + - -->“ is displayed.

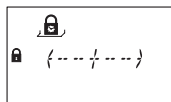

---

#### **Note!**

*If the maximum of 22 Holiday Locking Periods are already defined „<----->“ is displayed. No additional Locking Period can be defined.*

---

4. Press the <ENTER> key.
5. Use the <NUMERIC> keys to set the month (January= 01, February= 02, ... December= 12) the day and the year of the **starting point of the Holiday Locking Period** (indicated by the „lock closed“ symbol).



6. Press the <ENTER> key to confirm the settings in the upcoming save dialogue.

- Use the <NUMERIC> keys to set the month (January= 01, February= 02, ... December= 12) the day and the year of the **end point of the Holiday Locking Period** (indicated by the „lock open” symbol).



- Press the <ENTER> key to confirm the settings in the upcoming save dialogue.



**Notes!**

- Holiday Locking Periods last from 00:00:00 (12:00 AM) of the first day until 23:59:59 (11:59:59 PM) of the last day.*
- The maximum duration of a Holiday Locking Period is limited to 35 days.*
- Between two Holiday Locking Periods a time gap of at least 1 day must be observed. Exception: Feb 28<sup>th</sup> – March 1<sup>st</sup> due to leap year.*
- Holiday Locking Periods are saved in chronological order.*
- During an active Holiday Locking Period possibly defined Weekly Locking Periods (→ Configuring Weekly Locking Periods - Submenu WEEKLY on page 47) have no effect – the Holiday Locking Period is simply overlaid.*
- Entering „0000” for both, starting and ending year will repeat the Holiday Locking Period every year.*
- If the end date of a yearly repeated Holiday Locking Period is to be last day of February, it is recommended to set it to February 29<sup>th</sup> in order to include leap years as well.*

**6.4.2.3.2 Modifying an existing Holiday Locking Period**

Proceed as described for adding a new Holiday Locking Period (→ *Adding a Holiday Locking Period on page 51*). Instead of „<- - + ->” select the Holiday Locking Period you wish to alter and overwrite it.

## Axessor USB

### 6.4.2.3.3 Deleting an existing Holiday Locking Period

1. Select submenu „Holiday“.



2. Press the <ENTER> key. The starting point of the first defined Holiday Locking Period is displayed.
3. Use the <LEFT> or <RIGHT> key to select the starting point of the Holiday Locking Period (indicated by the „lock closed“ symbol) you wish to delete.



4. Press the <DEL> key.
5. In the upcoming delete dialogue select „YES“ using the <LEFT> or <RIGHT> key, then press the <ENTER> key.



---

#### **Important!**

*Once elapsed, Holiday Locking Periods that carry a year value (not 0000) are automatically deleted! This also applies if the date is accidentally set to a future date and then reset to a date in the past!*

---



### 6.4.3 Menu DELAY

#### 6.4.3.1 Setting/Deactivating Time Delays - Submenus DELAY 1...2

Once a valid code is entered, the lock only opens after the configured time delay has elapsed. A time delay can be set between 0 (deactivated, no Time Delay) and 99 minutes. Time Delays can be programmed:

- Time Delay 1: valid for Master, Manager 1 and Users 11 ... 19
- Time Delay 2: valid for Manager 2 and Users 21 ... 29.

Authorization: **Master Code or Manager Code**

1. Select the submenu „DELAY 1“ or „DELAY 2“.



2. Press the <ENTER> key. The currently set Time Delay is displayed.



3. Use the <Numeric> keys to set the desired Time Delay (setting range „00:00“ (deactivated, no Time Delay) to „99:00“ minutes).



**Note!**

- Upon delivery Time Delays are deactivated (set to „00:00“).
- The programmable maximum value of a Time Delay may be limited by the minimum time gap between two Weekly Locking Periods (➔ Adding a Weekly Locking Period on page 47)
- Entering a Courier Code opens the lock without any Time Delay.

4. Press the <ENTER> key to confirm the setting in the upcoming save dialogue.



---

### **AS 284 Programming software**

- *Two Duress Time Delays can be configured:*
    - *Duress Time Delay 1: valid for Master, Manager 1 and Users 11 ... 19*
    - *Duress Time Delay 2: valid for Manager 2 and Users 21 ... 29.*
  - *The Duress Time Delays can be set independent (longer or shorter) of normal Time Delays.*
  - *It is also possible to suppress Time Delays with an external signal (→ External connections at the lock on page 23). This allows to open the lock (e.g. to empty ATMs) without a Time Delay.*
-

### 6.4.3.2 Configuring the Confirmation Window - Submenu CNF WIN

To prevent the lock from automatic opening once a Time Delay has elapsed, a confirmation window is displayed, during which a code has to be entered again within a certain time.

Authorization: **Master Code or any Manager Code**

1. Select the submenu „CNF WIN“.



2. Press the <ENTER> key. The currently set confirmation time is displayed.

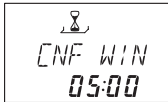

3. Use the <Numeric> keys to set the desired confirmation time (setting range „1:00“ to „99:00“ minutes).



---

**Note!**

- Upon delivery Confirmation Window is set to 5 minutes.
  - The minimum value is 1 minute.
  - The programmable maximum value of a Time Delay may be limited by the minimum time gap between two Weekly Locking Periods (→ Adding a Weekly Locking Period on page 47).
  - The Confirmation Window can not be deactivated.
- 

4. Press the <ENTER> key to confirm the setting in the upcoming save dialogue.





## 6.4.4 Menu CODE

The following table shows the authorizations of codes to perform modifications (for an overview of available code types (→ *Code types on page 31*)).

can be modified by owner of...	Master Code	Manager Codes	User Codes	Courier Code
Master Code	M	A M D	A M D	A M D
respective Manager Code	–	M	A M D	–
respective User Codes	–	–	M	–
Courier Code	–	–	–	M

Legend: **A** Activate                      **M** Modify                      **D** Delete

### 6.4.4.1 Changing the Master Code - Submenu MASTER

Authorization: **Master Code**

1. Select the submenu „MASTER“.



2. Press the <ENTER> key.



3. Select „YES“ (using the <LEFT> or <RIGHT> key), then press the <ENTER> key.

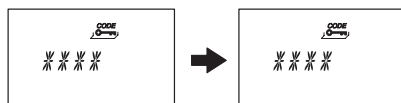

4. Use the <NUMERIC> keys to enter the new code.
5. Press the <ENTER> key to confirm.

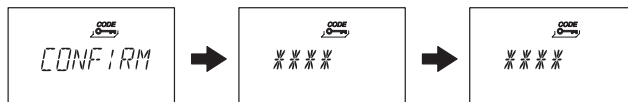

6. „CONFIRM“ is displayed shortly to prompt you to enter the same code again for confirmation. Use the <NUMERIC> keys to enter the same code again.
7. Press the <ENTER> key to confirm.

### 6.4.4.2 Setting Manager Codes - Submenu MANAGER

Authorization: **Master Code or respective Manager Code**

1. Select the submenu „MANAGER“.



2. Press the <ENTER> key.
3. This step must be performed only, if programming mode was entered with Master Code or Dual Manager Code: use the <LEFT> or <RIGHT> key to select the Manager Code you wish to alter (Manager Codes already activated are displayed by „USED“ not activated codes are displayed by „- - - -“).



4. Press the <ENTER> key. If you have selected an already activated code you are asked whether or not you want to modify the code.
5. Select „YES“ (using the <LEFT> or <RIGHT> key), then press the <ENTER> key.



6. Use the <NUMERIC> keys to enter the new code.
7. Press the <ENTER> key to confirm.

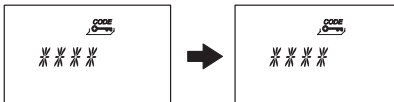

8. „CONFIRM“ is displayed shortly to prompt you to enter the same code again for confirmation. Use the <NUMERIC> keys to enter the same code again.
9. Press the <ENTER> key to confirm.

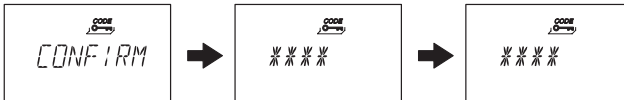

## 6.4.4.3 Setting User Codes - Submenu USER

Authorization: **Master Code, respective Manager Code or respective User Code**

1. Select the submenu „USER“.



2. Press the <ENTER> key.
3. This step must be performed only, If programming mode was entered with Master Code or a Manager Code: use the <LEFT> or <RIGHT> key to select the User Code you wish to alter (User Codes already activated are displayed by „USED“ not activated codes are displayed by „- - - - -“).



4. Press the <ENTER> key. If you have selected an already activated code you are asked whether or not you want to modify the code.



5. Select „YES“ (using the <LEFT> or <RIGHT> key), then press the <ENTER> key.

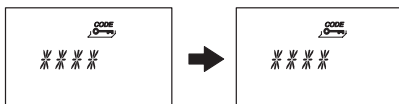

6. Use the <NUMERIC> keys to enter the new code.
7. Press the <ENTER> key to confirm.

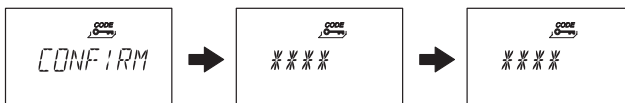

8. „CONFIRM“ is displayed shortly to prompt you to enter the same code again for confirmation. Use the <NUMERIC> keys to enter the same code again.
9. Press the <ENTER> key to confirm.

### 6.4.4.4 Setting the Courier Code - Submenu COURIER

Authorization: **Master Code or Courier Code**

1. Select the submenu „**COURIER**“.



2. Press the **<ENTER>** key.



3. A Courier Code already activated is indicated with „**USED**“, a Courier Code not activated it is indicated by „**- - - -**“. Press the **<ENTER>** key. If the Courier Code is already activated you are asked whether or not you want to modify the code.



4. Select „**YES**“ (using the **<LEFT>** or **<RIGHT>** key), then press the **<ENTER>** key.

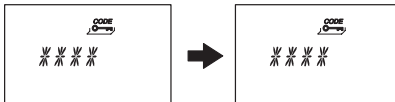

5. Use the **<NUMERIC>** keys to enter the new code.
6. Press the **<ENTER>** key to confirm.

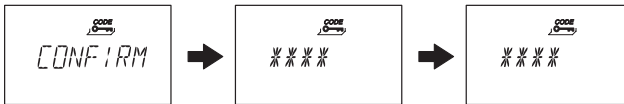

7. „**CONFIRM**“ is displayed shortly to prompt you to enter the same code again for confirmation. Use the **<NUMERIC>** keys to enter the same code again.
8. Press the **<ENTER>** key to confirm.

## 6.4.4.5 Reset the whole Axessor USB safe lock system to factory defaults - Submenu SHELVE



### **Important!**

The Employment of the Shelve Function will erase all codes and will set all parameters, such as Time Delay, Time Lock function, Dual Mode, display language, inputs, outputs, etc. to factory set values. Time/date, opening counter and Audit Trail will remain unchanged.

- Before continuing, be aware that all data will be lost!
- Saving data with AS 284 Programming Software prior to shelving is recommended!
- Take note that codes cannot be saved!

Authorization: **Master Code**

1. Select the submenu „SHELVE“.



2. Press the <ENTER> key.



3. You are asked whether or not you are sure to reset all data of the Axessor USB back to factory default setting. Select „YES“ (using the <LEFT> or <RIGHT> key), then press the <Enter> key. All data is reset to factory default settings.

### 6.4.4.6 Modifying a code

Authorization: → Access Codes on page 31

1. Select the Menu „CODE“.



2. Press the <ENTER> key.
3. This step must be performed only, if the Programming Mode was entered with a code of a higher level, than the one you wish to alter: use the <LEFT> or <RIGHT> key to select the **code type** (e.g. „User“) you wish to alter. Press the <ENTER> key. Use the <LEFT> or <RIGHT> key to select the **Code** (e.g. „User 11“) you wish to alter.
4. Press the <ENTER> key. You are asked whether or not you want to modify the code



5. Select „YES“ (using the <LEFT> or <RIGHT> key), then press the <ENTER> key.



6. Use the <NUMERIC> keys to enter the new code.
7. Press the <ENTER> key to confirm.

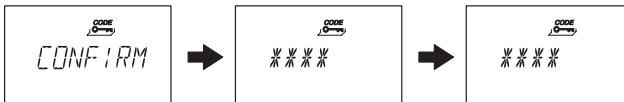

8. „CONFIRM“ is displayed shortly to prompt you to enter the same code again for confirmation. Use the <NUMERIC> keys to enter the same code again.
9. Press the <ENTER> key to confirm.

## 6.4.4.7 Deleting a code

Authorization: → [Access Codes on page 31](#)

1. Select the Menu „CODE“.



2. Press the <ENTER> key.
3. Use the <LEFT> or <RIGHT> key to select the **code type** (e.g. „User“) you wish to alter, then press the <ENTER> key.



4. Use the <LEFT> or <RIGHT> key to select the **Code** (e.g. „User 11“) you wish to alter.



5. Press the <DEL> key. You are asked whether you want to delete the code.



6. Select „YES“ (using the <LEFT> or <RIGHT> key), then press the <ENTER> key
7. Press the <ENTER> key to confirm the deletion.



---

### **Note!**

- *The Master Code cannot be deleted.*
  - *Upon deletion of a Manager Code the corresponding group of User Codes remain unchanged and will not be deleted.*
-



## 6.4.5 Menu MISC

### 6.4.5.1 Activating/Deactivating Code Denial - Submenu CDE DEN

A higher-level code can deny access for lower-leveled codes until possible re-permission. As an example, „Off-Duty-Shifts“ can be locked out and reassigned again once they start their shift.

An entire User Group (with or without its corresponding Manager Code) can be denied from access.

*Authorization: Master Code or any Manager Code*

1. Select the submenu „CDE DEN“.

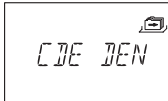

2. Press the <ENTER> key. The Code Denial status of the User Group 1 is displayed.



3. Use the <LEFT> or <RIGHT> key to select the desired User Group or Manager.
4. Press the <ENTER> key to confirm your selection.



5. Use the <LEFT> or <RIGHT> key to **activate** („CDE DEN ON“, **access denied**) or **deactivate** („CDE DEN OFF“, **access permitted**) the Code Denial for the corresponding User Group or Manager.
6. Press the <ENTER> key to confirm the setting in the upcoming save dialogue.
7. Repeat steps 2 to 5 for all User Groups and Managers desired.



#### **AS 284 Programming Software**

- Every single User can be denied individually.
- A User can be denied even if the code itself is not yet programmed.
- When calling up the Code Denial submenu, code groups with a mixture of denied and permitted codes are indicated with „<- □ - □->“ in the display.



## 6.4.5.2 Activating/Deactivating Remote Disabling - Submenu RMT-DIS

Opening of the closed lock can be disabled by an external signal. This function can e.g. be employed when additional identification (e.g. badge, biometrics) is desired or to prevent opening during certain circumstances (e.g. when alarm system is armed).



**Note!**

*The function is not active when lock is open – lock can then be operated normally.*

Authorization: **Master Code**

1. Select the submenu „RMT-DIS“.

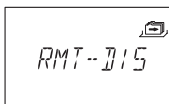

2. Press the <ENTER> key. The currently set status of the Remote Disabling function (by default: „OFF“) is displayed.

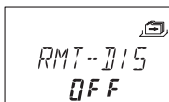

3. Use the <LEFT> or <RIGHT> key to **activate** („RMT-DIS ON“) or **deactivate** („RMT-DIS OFF“) the Remote disabling function.
4. Press the <ENTER> key to confirm the setting in the upcoming save dialogue.

### 6.4.5.3 Activating/Deactivating Duress Code function - Submenu DURESS

If the lock is connected to an external alarm system, a silent duress alarm (not noticeable for the aggressor) can be triggered by entering a Duress Code (→ *Duress Code on page 34*).

Duress Codes are recognized if this function has been activated.

Entering the Duress Code for opening the lock also starts the defined Duress Time delay.

*Authorization:*           **Master Code**

1. Select the submenu „**DURESS**“.



2. Press the <ENTER> key. The currently set status of the Duress Code (by default: „OFF“) is displayed.



3. Use the <LEFT> or <RIGHT> key to **activate** („**DURESS ON**“) or **deactivate** („**DURESS OFF**“) the Duress Code recognition.
4. Press the <ENTER> key to confirm the setting in the upcoming save dialogue.



---

#### **AS 284 Programming Software**

- *The Duress Time Delay can be set independent (longer or shorter) of the Time Delay.*
-

## 6.4.5.4 Activating/Deactivating Dual Mode - Submenu DUAL

The lock can be set to require 2 codes for opening. It can be employed when only 2 people together are supposed to be able to open the lock.

Authorization: **Master Code**

1. Select the submenu „DUAL“.



2. Press the <ENTER> key. The currently set status of the Dual Mode (by default: „OFF“) is displayed.



3. Use the <LEFT> or <RIGHT> key to **activate („DUAL ON“)** or **deactivate („DUAL OFF“)** Dual Mode.
4. Press the <ENTER> key to confirm the setting in the upcoming save dialogue.



### Note!

- *Master Code (if set to „Master can open Lock“) and Courier Code can open the lock without any second code.*
- *If Opening Time Delay is activated:*
  - *Two codes must be entered for verification in the Confirmation Window, once the Time Delay has elapsed. Here again, above mentioned Dual Mode settings apply.*
  - *if two codes were entered, the opening delay of the last code will be performed. Exception: if the first entered code was a Duress Code, its Duress Time Delay will be performed.*
  - *if Master Code or Courier Code is entered first in Confirmation Window no second code will be required upon confirmation.*



### AS 284 Programming Software

- *Master Code can be defined as „cannot open“. If so, the Master Code can neither be used to open the lock nor to start the Time Delay. The message „DENIED“ is shown instead. However, if only one operable code is programmed in Dual Mode, Master Code can open, though!*

### 6.4.5.5 Setting the display language - Submenu LANG

By default the system language is set to English. If desired, the display language can be set to another language.



---

**Note!**

- *The display language can be modified without entering a access code via the language indication in the information menu.*
- 

Authorization: **Master Code or any Manager Code**

1. Select the submenu „**LANG**“.



2. Press the **<ENTER>** key. The currently set display language (by default: „ENGLISH“) is displayed.



3. Use the **<LEFT>** or **<RIGHT>** key to select desired display language.
4. Press the **<ENTER>** key to confirm the setting in the upcoming save dialogue.

## 7 Servicing

### 7.1 Cleaning

If necessary, clean the outside of the Input Unit with a soft, damp cloth and a mild household cleaning agent.



#### **Warning!**

- *On no account use any cleaning agents, which contain solvents or other aggressive substances.*
- *Ensure that no liquid comes into contact with the Input Unit.*

### 7.2 Replacing the batteries

The Input Unit is powered by three **1.5 Volt ALKALINE batteries** or **1.5 Volt Lithium batteries (type AM3, AA)** with a service life of approximately 2 to 3 years (about double with Lithium batteries).



Batteries must be replaced once the „battery low“ symbol appears in the display, at least if the text prompts „CHANGE BATT“. The lock remains fully operational until the battery voltage drops below the value required for correct operation.

Proceed as follows:

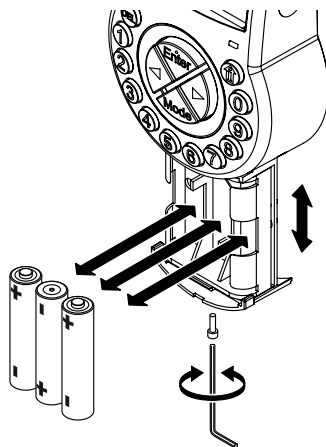

1. Undo the screw of the battery compartment on the bottom side of Input Unit.
2. Carefully slide out the battery compartment until it comes to a stop.
3. Replace old batteries by 3 new ones of the same type (3x AA mignon, Alkaline or Lithium type). **Observe polarity** (see polarity markings in receptacles).



**Warning!**

If the Lock is without power for more than 5 minutes the internal clock will cease and reset to the last clock hour. All other settings are saved in the power-failure proof memory of the Input Unit. To set time and date anew as described on page 44 (→ Menu TIME).

- As soon as the batteries are inserted a test routine is initiated. The following displays appear successively (version display may vary) and the „BEEP signal“ sounds:



- Close the battery compartment and fix it with the screw. Wait until the error message „BAT-CMP OPEN“ reappears again.

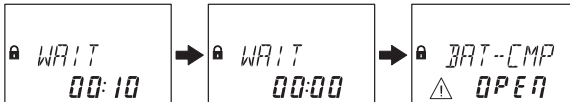

- Confirm the message by entering the Master Code or one of the Manager Codes. The lock opens and closes again after the set opening time. The Lock is in normal operating mode.

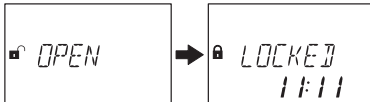

If no reaction on Master Code or Manager Code: close lock **with door open**.

If still no reaction: wait 2 minutes and enter Master Code or Manager Code again.



**Important!**

Do not dispose of used batteries in domestic waste. Please return used batteries to the vendor or dispose of the batteries according to the applicable local regulations.

### 7.3 Customer Service

Should any functional errors or operating problems occur, please contact your safe supplier (→ refer to rear cover of this manual for contact details).

## Axessor USB

### 7.4 Spare parts and accessories

Following items are available:

<b>Accessories</b>	<b>Part number</b>
Power supply 230V -> 5,9V for Axessor USB lock: - Manufacturer: FRIWO GERAETEBAU GMBH - Model number: FW7600/06	52xVDC6
Axessor AS 284 Programming Software	AS284-USBW
User dongle for Axessor AS284 Programming Software (spare or additional dongle)	AS284-OW **
<b>Spare parts</b>	
Axessor USB lock unit (model number: 3582701302)	AXESSOR-USBLOCK
Axessor USB input unit (model number: 3310300310)	AXESSOR-USBIU
Battery compartment for Axessor input unit	52x BAT-S
Axessor installation kit	52x INST-S
USB data cable 1.8 m	1364-8
Connection cable lock/input unit, 30 cm	52x+CAB30
Connection cable lock/input unit, 55 cm	52x+CAB55
Connection cable lock/input unit, 80 cm	52x+CAB80
Connection cable lock/input unit, 120 cm	52x+CAB120
Connection cable lock/input unit, 150 cm	52x+CAB150

\*\* Note on AS284-OW dongle: the USB dongle is also available as licence file on request (e.g. for virtual environments). The appropriate part number in this case is AS284-OWV.

## 8 Error messages

Operating errors, false entries or possible defects can result in error messages. Their significance and most possible cause are described in table below.

Display	Menu	Submenu	Cause
BAT-CMP OPEN			Battery compartment has been opened.
LINE OFF			Connection between lock and Input Unit is interrupted.
ID ERR	CODE	MASTER MANAGER USER COURIER	ID is not „00“ ID is not „10“ or „20“ ID is not „11...19“ ID is not „90“
REFUSED	CODE	MASTER MANAGER USER COURIER	Code modification: Code entered did not match the code entered first.
REFUSED 02			Unknown command. Desired function not available. Installed components not compatible. Call vendor for technical support.
REFUSED 04	PROG	IMM-TL	No Weekly Locking Period programmed.
	after confirmation of an entry in Programming Mode		Lock is closed (programming possible with lock open only!)
REFUSED 08	TIME	DATE	<ul style="list-style-type: none"> <li>Invalid date (e.g. Sep 31<sup>st</sup>).</li> <li>Date out of limit (Jan 1<sup>st</sup> 2002 until Dec 31<sup>st</sup> 2099).</li> </ul>
	PROG	WEEK	Time window too long (max. 6 days, 23 hours, 59 minutes).
	PROG	HOLIDAY	<ul style="list-style-type: none"> <li>Time window too long (max. 35 days)</li> <li>End date before start date</li> <li>Invalid date (e.g. Sep 31<sup>st</sup>)</li> <li>Date out of limit (Jan 1<sup>st</sup> 2002 until Dec 31<sup>st</sup> 2099)</li> </ul>



## Axessor USB

Display	Menu	Submenu	Cause
REFUSED 16	PROG	WEEK	Minimum interval (pause) of 1 day until start of next Weekly Locking Period ignored. Also observe delay / confirm window limits.
	PROG	HOLIDAY	Minimum interval (pause) of 1 day until start of next Weekly Locking Period ignored. Also observe delay / confirm window limits.
	PROG	DELAY	Observe delay / confirm window limits in relation to Weekly and Holiday Locking Periods. The minimum time period is calculated by adding the confirmation window plus one minute to the bigger value of the two delay times (time delay or duress time delay).
REFUSED 32	PROG	WEEK	Memory full (max. 16 Weekly Locking Periods)
	PROG	HOLIDAY	Memory full (max. 22 Holiday Locking Periods)
REFUSED 64			Unexpected data error. Try again. Call vendor for technical support if error keeps re-appearing.
REFUSED 128			Lock is no longer in programming mode (only menu navigation but no data sent to lock for >5 minutes).
MOT FLT			Motion Fault during bolt movement. <ul style="list-style-type: none"> <li>• Reboot unit by removing batteries for 15 minutes and inserting new batteries.</li> <li>• Check if bolt movement is smooth or if bolt is mechanically blocked</li> <li>• Call vendor for tech support (replace lock)</li> </ul>

Display	Menu	Submenu	Cause
HDW FLT			Hardware fault: Proceed as with MOT FLT.

If multiple causes lead to multiple error messages „REFUSED xx“, the error numbers will be added.

Examples:

REFUSED 12 = REFUSED 04 + REFUSED 08

REFUSED 50 = REFUSED 02 + REFUSED 16 + REFUSED 32

## 9 Technical data

### 9.1 Functions

Code functions	
Code format	<b>ID (2-digit) + PIN (6-digit)</b>
Code types	<b>1 Master Code</b> (8 digits) bearer: e.g. Safety Officer, Head of Security, etc. Note: can open alone in Dual Mode. Note: Can be set to „cannot open“ with AS 284 Programming Software.
	<b>2 Manager Codes</b> (8 digits each) bearer: e.g. Head Cashier, Shift Manager, etc. Note: Can be set to „Manager can activate immediate time lock“ with AS 284 Programming Software.
	<b>18 User Codes</b> (8 digits each, subordinated in 2 groups of 9 each to the respective Manager Code) bearer: e.g. Cashier, Sales Assistant.
	<b>1 Courier Code</b> (8 digits, opening permission without opening delays) bearer: e.g. auditor, CIT (Cash In Transit service provider), etc. Note: opens alone in Dual Mode.
Code options	<b>Duress Code</b> (can be performed by any code, if function is activated).
	<b>Dual Mode</b> (two codes needed) Note: Master Code and Courier Code can open alone.
	<b>Code denial</b> (individual codes or entire code groups can be admitted/disabled).

<b>Time functions</b>	
Date / Time	Continuous calendar until 2099.
Summer/winter time (Daylight Saving Time)	Algorithm (e.g. last Sunday in May), Note: requires AS 284 Programming Software.
Locking periods	16 Weekly Locking Periods (repeated weekly, each up to 7 days long). 22 Holiday Locking Periods (date-related, each up to 35 days long, can be defined as yearly repeatable).
Immediate Time Lock	Locking with immediate action for a selectable duration (max. 144 hours).
Time Delays	2 Time Delays (each programmable from 0...99 min). • Time Delay 1: valid for Master, Manager 1 and User 11...19 • Time Delay 2: valid for Manager 2 and User 21...29
Duress Time Delays	2 Duress Time Delays (99 min). • Duress Time Delay 1: valid for Master, Manager 1 and User 11...19 • Duress Time Delay 2: valid for Manager 2 and User 21...29  Note: Duress Time Delay can be changed with AS 284 Programming Software only
Confirmation Window	Programmable from 1...99 minutes
<b>General</b>	
Locking	Automatically: after 6 seconds. Programmable from 6 to 60 seconds with AS 284 Programming Software. Manually: Upon pressing DEL key. After closing of boltwork.
Event memory	approx. 10'000 event entries, protected against manipulation and power failure.
Shelve Function	Master Code can delete, respectively reset all codes, functions and settings back to factory default values at once.

# Axessor USB

## 9.2 Electronics

General	
Power supply	3 Alkaline or Lithium batteries 1.5 V LR6 (AA, AM3, E91), service life approx. 3-4 years (with 1 opening/closing cycle per working day, no load on lock bolt)
Memory	Non-volatile (protected against power failure)
Display	Iconographic LCD with high contrast, display language user selectable (English, Dutch, French, German, Hungarian, Italian, Polish, Portuguese, Spanish and Turkish).
Keypad	Silicone keys (10 numeric, 4 function, 2 navigation keys).
Interfaces	
Outputs	<p>2 potential free contacts for alarms (30VDC / 2A, 50VAC / 0.5A with resistive load).</p> <p>Output 1: Duress Alarm (factory setting) Output 2: Bolt or motor open (factory setting)</p> <p>With the Programming Software AS 284 the outputs can be programmed for different applications. For this, e.g. the following events are available:</p> <ul style="list-style-type: none"><li>• Lock open</li><li>• Door open</li><li>• Active time delay</li><li>• Active penalty time</li><li>• Duress code entry</li><li>• Battery compartment open</li><li>• and more...</li></ul>
Inputs	<p>Input 1 (signal-triggered 12VDC / 20mA): not programmed (factory setting) Input 2 (contact triggered): not programmed (factory setting)</p> <p>With the Programming Software AS 284 the inputs can be programmed for different functions, e.g.:</p> <ul style="list-style-type: none"><li>• Remote activation - remote disabling</li><li>• Door contact, interruption of delay time</li><li>• etc.</li></ul> <p>Note: not all events can be assigned to the inputs.</p>
USB	Connection to a computer for configuration with AS 284 Programming Software

### 9.3 Mechanics

<b>Lock</b>	
Dimensions	85 x 61 x 33 mm
Weight	495 g
Mounting	3 screws M6 (template 67 x 41 mm)
Motor bolt	dead bolt (optional: spring bolt)
Relocker	integrated lock relocker
Cycle times	opening/closing approx. 2 seconds
Static resistance force	>1000 N in all directions
Moving force	max. 5 N both directions
Environmental conditions	operation: 0...+60°C / storage: -40...+70°C
Service life	>50 000 cycles
PCB designation	A21-P-01-05_L
<b>Input Unit</b>	
Dimensions	128 (193) x 90 x 40 mm
Weight	660 g (including connection cable and batteries)
Environmental conditions	operation: 0...+60°C / storage: -40...+70°C / system of protection: IP53
PCB designation	A08-P-03-04

### 9.4 Approvals and Certificates

Test marks	CE
Patent No.	US 6,434,987 B1; EP 1 069 264 B1
VdS (VdS 2396)	Electronic high-security lock class 2, approval only valid if marked on lock.
ECB-S (EN 1300)	Electronic high-security lock level B, approval only valid if marked on lock.
Underwriter Laboratories (UL)	High security electronic lock type 1, approval only valid if marked on lock.  Note: The audit features, the software features, features associated with peripheral devices and systems, optional interconnect devices and their associated features, features involving the use of user keys, the duress feature, monitoring features, remote features, and other additional features have not been evaluated by UL.
CNPP a2p	Level B/E, approval only valid if marked on lock.

## 9.5 Factory settings

Function/Setting	Factory setting	Can be changed with	
		Input Unit	AS 284 (opt.)
Display language *a)	English	✓	✓
Master Code	0 0 1 2 3 4 5 6	✓	✓
Master Code settings	can open	–	✓
Manager Codes (max. 2)	not activated	✓	✓
User Codes (max. 2 groups of 9)	not activated	✓	✓
Courier Code	not activated	✓	✓
Courier Code settings	can open	–	–
Duress Code entry	not activated	✓	✓
Dual Mode	not activated	✓	✓
Dual Mode setting	any two codes	–	✓
Number of wrong codes until penalty	4	–	–
Penalty upon wrong code entries	5 minutes	–	–
Time Delays	0 minutes (deactivated)	✓	✓
Duress Time Delays	99 minutes	–	✓
Confirmation Window	5 minutes	✓	✓
Weekly Locking Period	not programmed	✓	✓
Holiday Locking Period / Repeated Holiday Locking Period	not programmed	✓	✓
Show next open possibility	on	–	✓
Date / time	01.01.2008 0:00	✓	✓
Time format (12/24hrs.)	24 hours	✓	✓
Summer/winter time (Daylight Saving Time)	n/a not programmed	–	✓
Input 1 *b) (connections 5 and 6)	not programmed	–	✓
Input 2 *c) (connections 7 and 8)	not programmed (remote disabling, controlled remote disabling, door contact, skip Time Delay)	–	✓



## Axessor USB

Function/Setting	Factory setting	Can be changed with	
		Input Unit	AS 284 (opt.)
Output 1 *d) (connections 3 and 4)	Duress alarm	–	✓
Output 2 *d) (connections 1 and 2)	bolt or motor open	–	✓
Remote Disabling	not activated	✓	✓
Buzzer volume	high	–	✓
Beep every 30 sec while lock open	on	–	✓
Beep every 60 sec while (Duress) Time Delay counts	on	–	✓
Beep every 60 sec while Confirmation Window counts	on	–	✓

- Remarks:
- \*a) English, Dutch, French, German, Hungarian, Italian, Polish, Portuguese, Spanish and Turkish can be selected.
  - \*b) Input 1 is signal-triggered (12V / 13mA).
  - \*c) Input 2 is contact-triggered.
  - \*d) Relay contacts 1 and 2 are working contacts (NO, normally open) with default factory settings.



# Axessor USB

## Template Input Unit

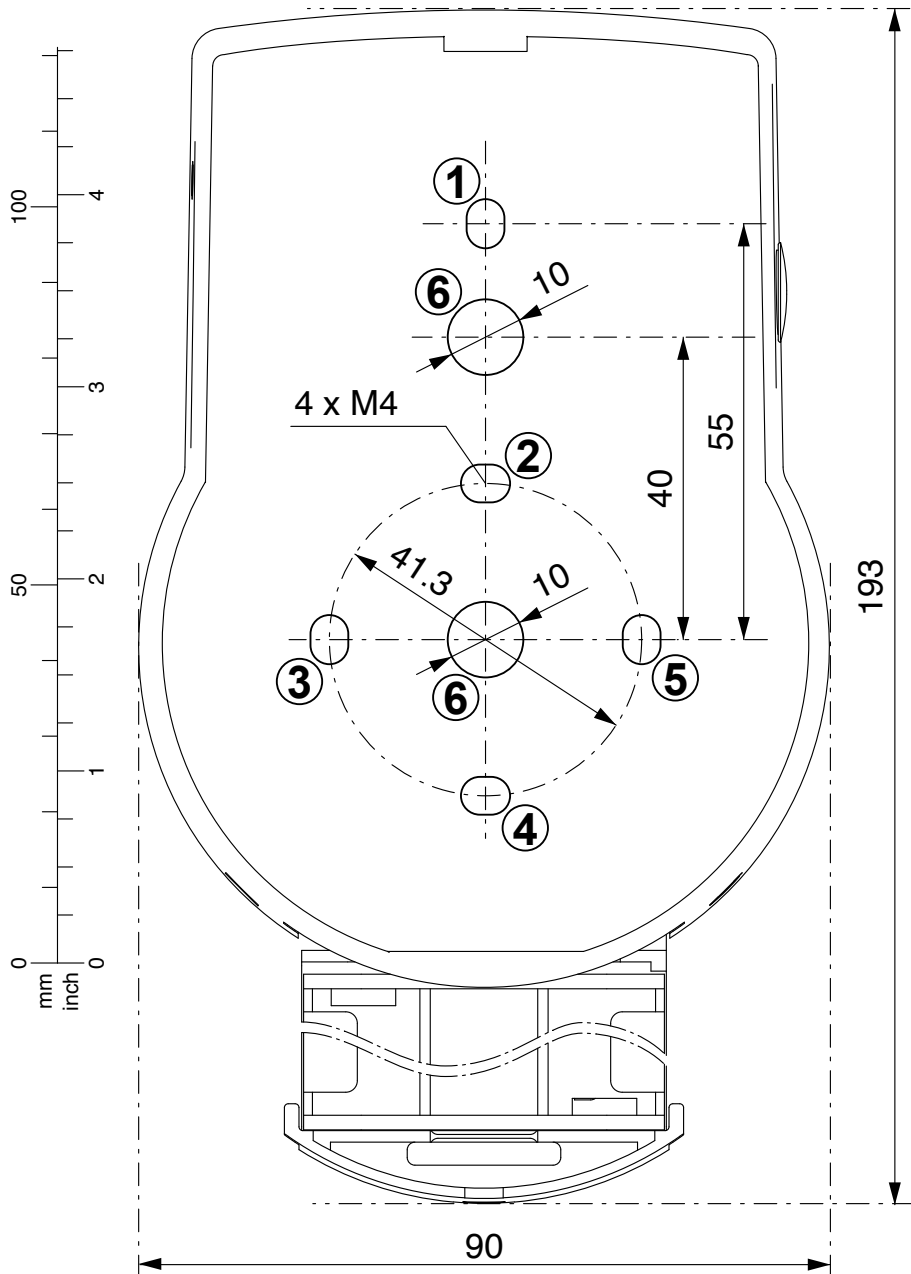

Template Lock

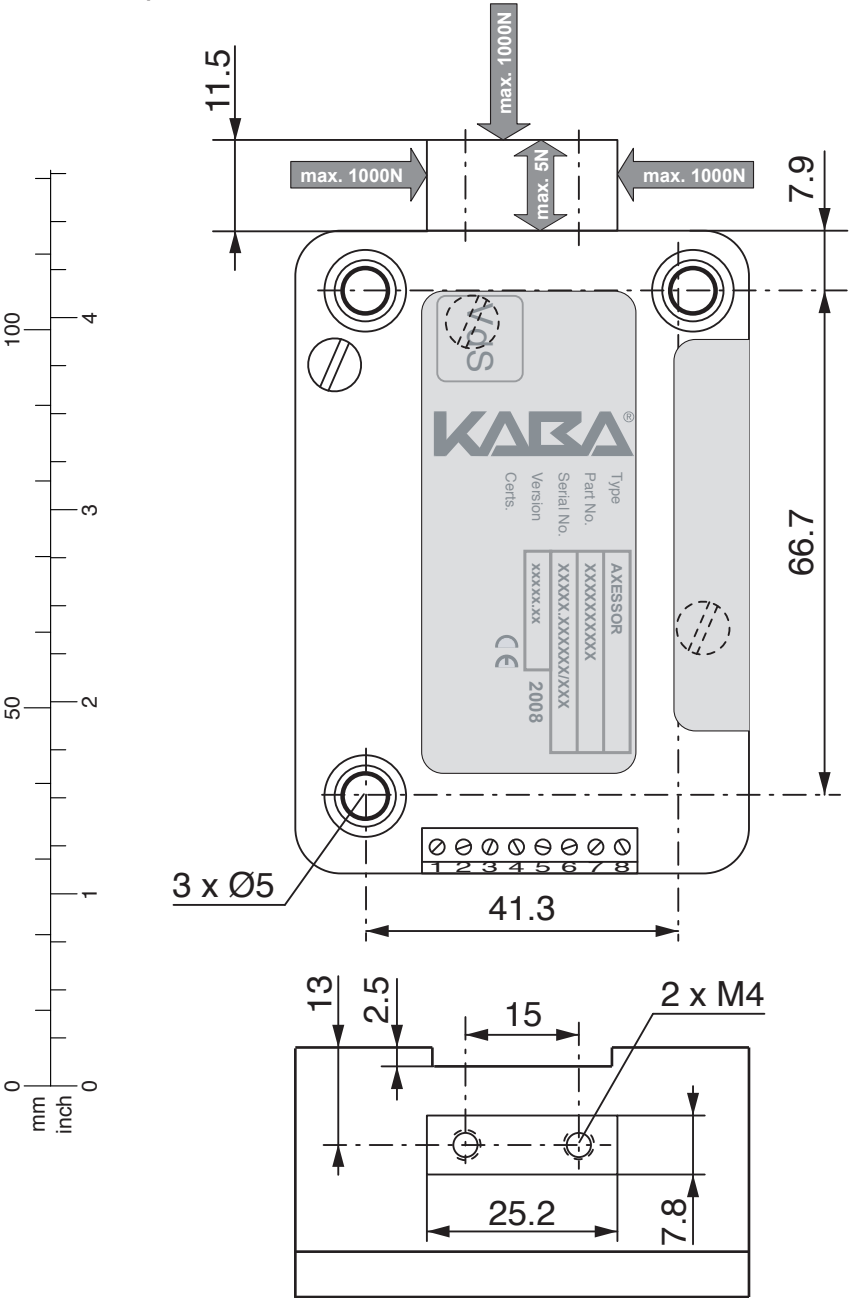





Kaba® is a registered trademark of Kaba AG

This documentation may not be reproduced or distributed in any way – neither in digital nor in photographic form – without prior written permission of Kaba AG. © by Kaba AG, CH-8620 Wetzikon.